

PRODUCT FACTSHEET

se:living

Sofa for cosy offices

With its comfortable upholstery, se:living radiates creativity and lightness in lounge and meeting zones, in hubs and collaboration areas. Whether as a single sofa, a corner unit or an island constellation, with storage elements, add-on or side tables – the sofa offers a wide range of options.

Design: Robin Rizzini

CONTENTS

Overview.....	2
Configurations.....	3
Construction.....	5
Electrification.....	6
System overview.....	7
Colour & material collections.....	12



ADDITIONAL LINKS

- ↓ [CAD-files](#)
- ↓ [Photos](#)
- ↓ [EPI – Environmental Product Information \(pdf\)](#)
- ↓ [Assembly instructions](#)
- ↓ [Certificates](#)
- ↗ [Product Configurator](#)

→ [find out more at the Sedus website](#)

se:living offers moments of well-being with plenty of comfort and convenience

FEATURES (STANDARD)

- Free-standing sofa elements or linking elements for customised sofa landscapes
- Wide range of predefined configurations
- Two seat depths (64 or 80 cm)
- Easy power supply option via the plinth or the add-on tables



OPTIONS/ACCESSORIES

- With/without armrests
- Electrification
- Add-on table
- Corner elements
- Plant element
- Large selection of side tables



CERTIFICATES

- GS label (in preparation)
- TÜV tested for harmful substances (in preparation)
- Greenguard (in preparation)
- Blauer Engel (Blue Angel) (in preparation)
- User weight
 - Sofa elements: up to 130 kg body weight per seat
 - Armchair: up to 130 kg body weight
 - Stool: up to 130 kg body weight
- Fire safety regulations: EN 1021, Part 1 & 2, UK FFFSR, Italy UNI Class 1.IM
- EPI (in preparation)



Optimal for waiting areas: the corner solution that is complemented with a planter tray

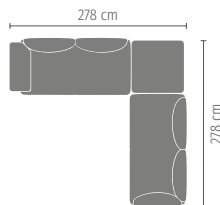

↓ [Download Dwg-file](#)
 ↓ [Download Dxf-file](#)

As a classic arrangement: sofa and armchair as a setting in combination with side tables

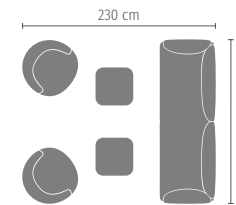

↓ [Download Dwg-file](#)
 ↓ [Download Dxf-file](#)

Innovative conference areas: with the diagonal sofa elements, meeting areas can be arranged into an inviting seating configuration

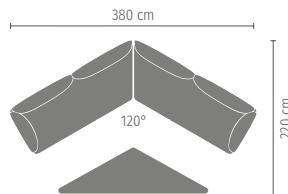

↓ [Download Dwg-file](#)
 ↓ [Download Dxf-file](#)

Individual solution: a corner configuration with different seat depths as well as with an open end on one side and an armrest on the other

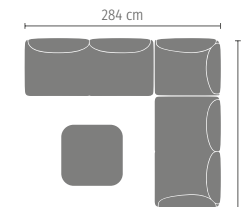

↓ [Download Dwg-file](#)
 ↓ [Download Dxf-file](#)

Free arrangement: a combination of armchairs and table as a central element creates a light and airy look

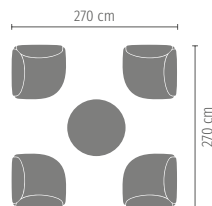

↓ [Download Dwg-file](#)
 ↓ [Download Dxf-file](#)

According to preference: thanks to different seat depths, everyone can choose their preferred side

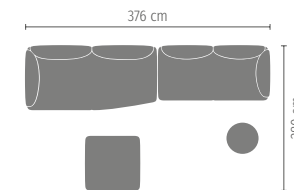

↓ [Download Dwg-file](#)
 ↓ [Download Dxf-file](#)

Statement for lounge and reception areas: the plant bench with the plant element in the middle

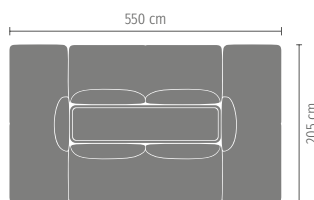

↓ [Download Dwg-file](#)
 ↓ [Download Dxf-file](#)

Seating landscape with added value: a practical and comfortable sofa constellation can be created by adding storage elements

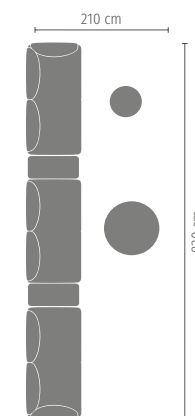

↓ [Download Dwg-file](#)
 ↓ [Download Dxf-file](#)

Construction and upholstery structure:
upholstered elements, stools,
armchairs (square)

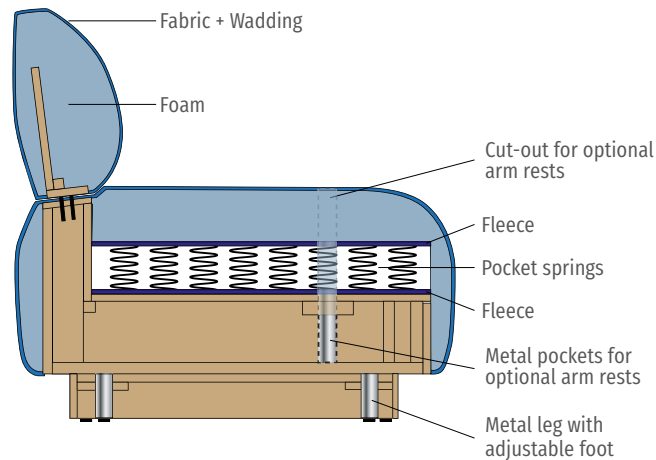

The upholstery structure consists of an 80-mm-high innerspring that sits loosely on the base frame. For sound insulation, a layer of fleece is loosely laid between the base frame, which has holes for ventilation, and the innerspring. Another layer of fleece lies loosely on the innerspring. The full-surface upholstery structure in sandwich construction is made of two layers which are contour-cut.

Backrest and armrest upholstery: The backrest and armrests are fitted into the frame using two black powder-coated steel tubes (29-mm diameter) and screwed into place from below.

It is possible to remove and replace the armrests at a later date. The backrest and armrests have a wooden support made of plywood. The full-surface upholstery structure in sandwich construction made of two layers is contour-cut. A 100-gram polyester fleece wadding is sewn under the cover.

Construction and upholstery structure:
Armchairs (round)



The upholstery structure consists of straps that are stretched crosswise and firmly connected to the wood. The full-surface upholstery structure in sandwich construction made of two layers is contour-cut.



Information on used materials and recyclability can be found in the [EPI – Environmental Product Information \(pdf\)](#)

Easy assembly of the sofa as well as easy fitting of the wiring. Cables and wires are stowed in the plinth and integrated discreetly in the floor in combination with a floor box



1. In the plinth, the power and USB ports can be placed centrally under the seat for easy access

2. The storage element is available as a starting, middle or end element and can be optionally equipped with a power supply

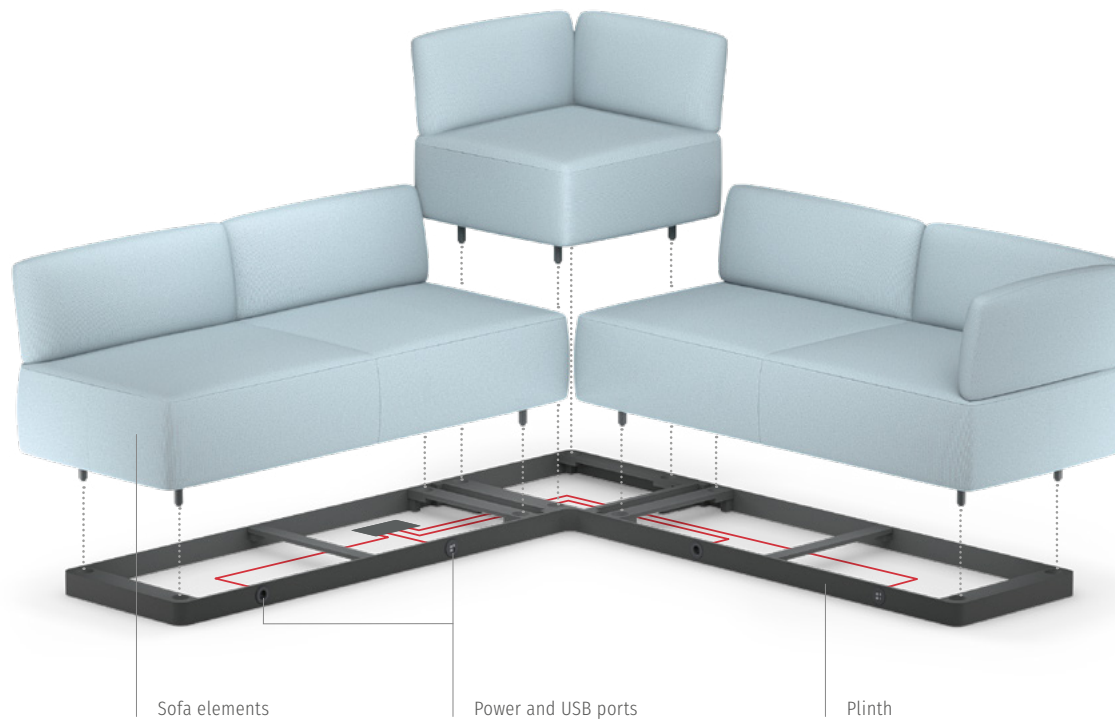

Free-standing elements

- *Options:
- open end
 - armrests
 - add-on table

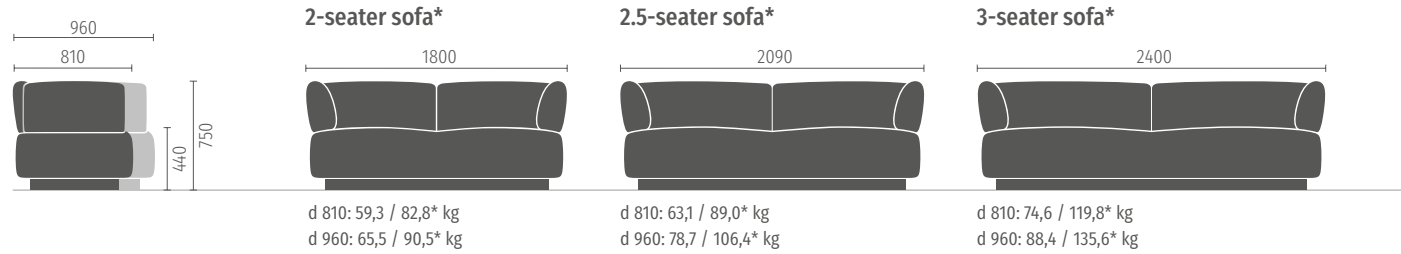

Armchair, square

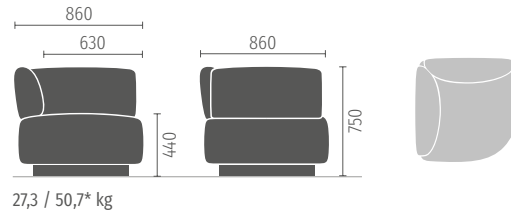

Armchair, round

Option: with swivel base and return mechanism +2,0 kg

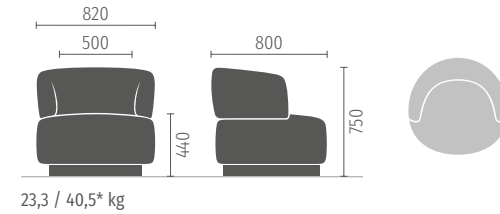

Pouf

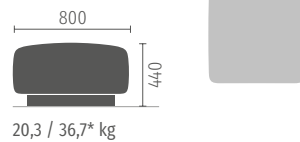

***Options**

1. with armrests



2. open end

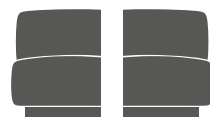

3. Add-on table



d 810: minus 3,6 kg per end
 d 960: minus 5,75 kg per end

plus 5,3 kg per end

all dimensions in mm

*weight incl. packaging

Modular elements

- *Options:
- open end
 - armrests
 - add-on table

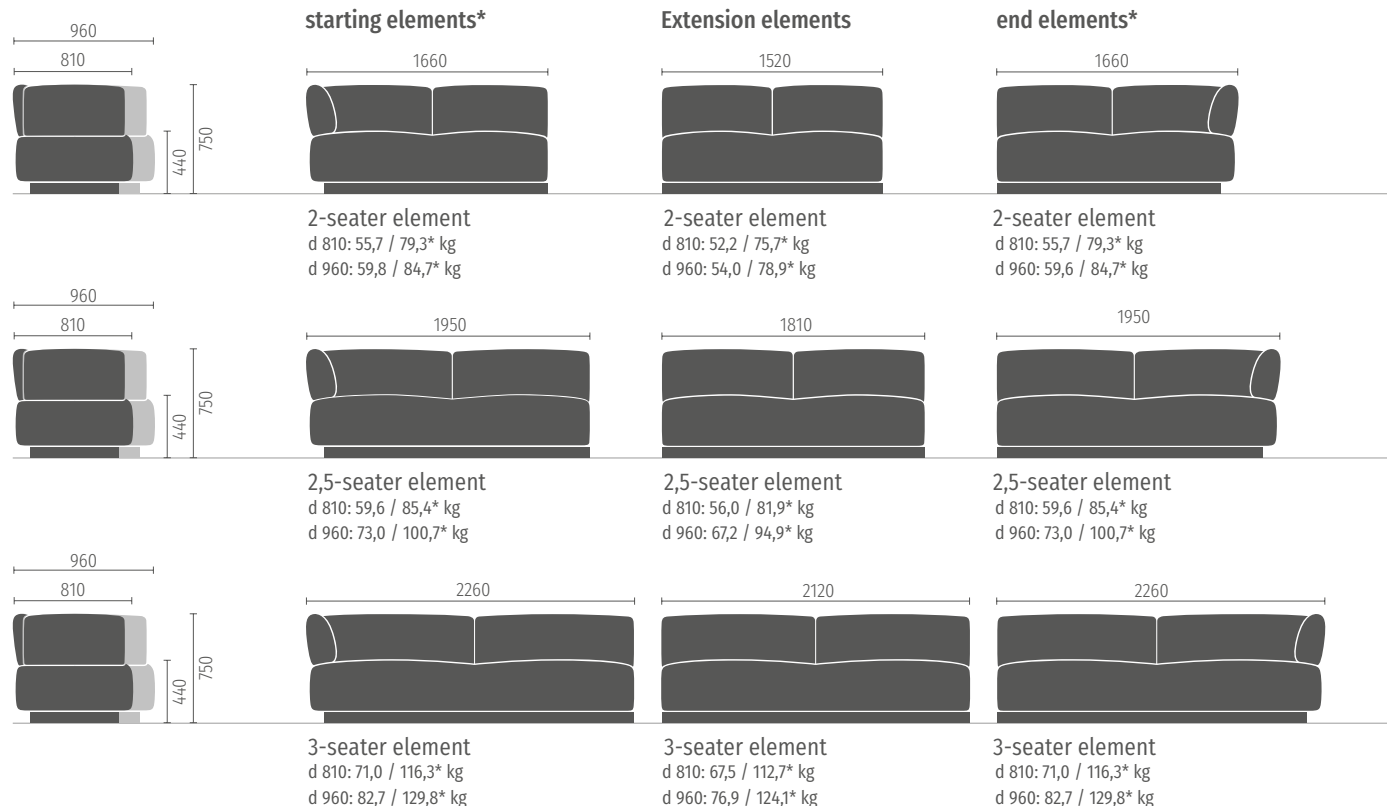

*Options

1. open end

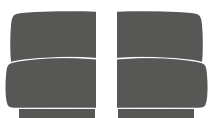

d 810: minus 3,6 kg per end
d 960: minus 5,75 kg per end

3. Add-on table

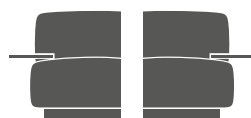

plus 5,3 kg per end

all dimensions in mm

*weight incl. packaging

Diagonal elements

- Options:
- open end
 - armrests
 - add-on table

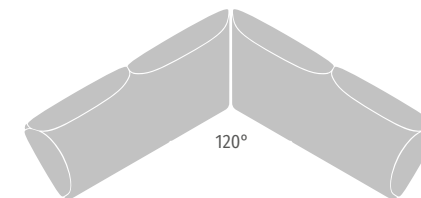
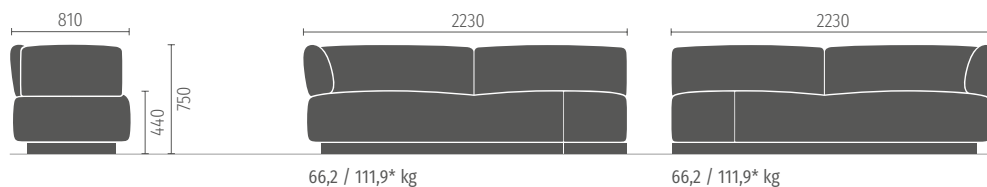

Element with 2 seat depths

- Options:
- open end
 - armrests
 - add-on table

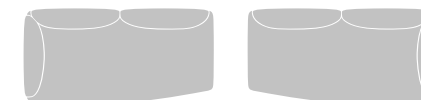

90° corner seating element (all dimensions in mm)

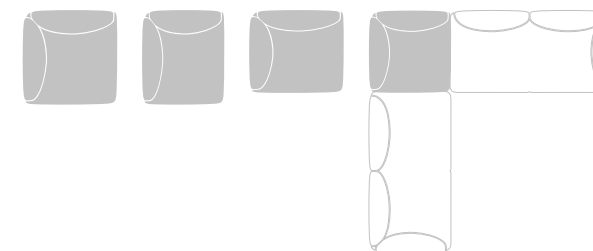
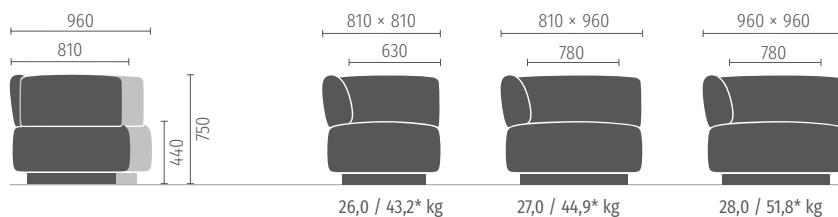

Corner elements

- Options:
- Corner element as storage can be optionally fitted with a power supply

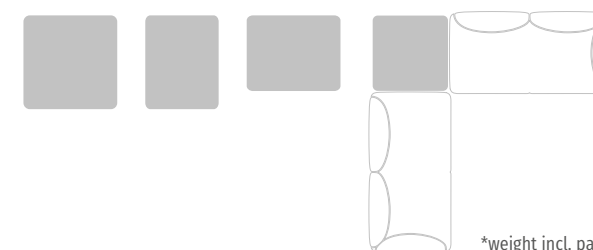
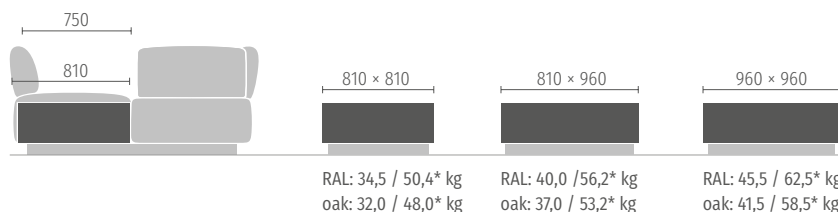

*weight incl. packaging

all dimensions in mm

Plant bench

- Options:
- With a counter top or as a planter tray
 - Counter top can be optionally fitted with a power supply

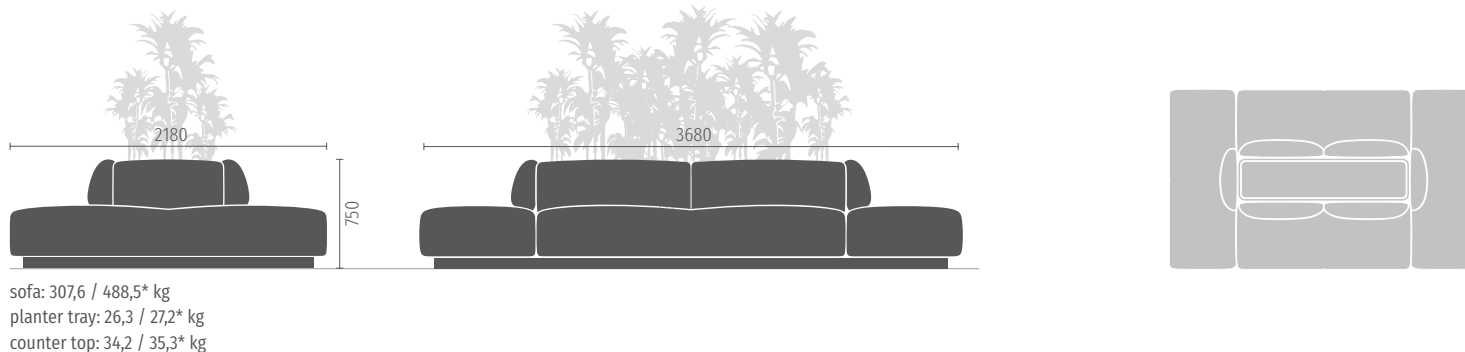

Storage elements

- Options:
- As a starting, middle or end element
 - Can optionally be fitted with a power supply

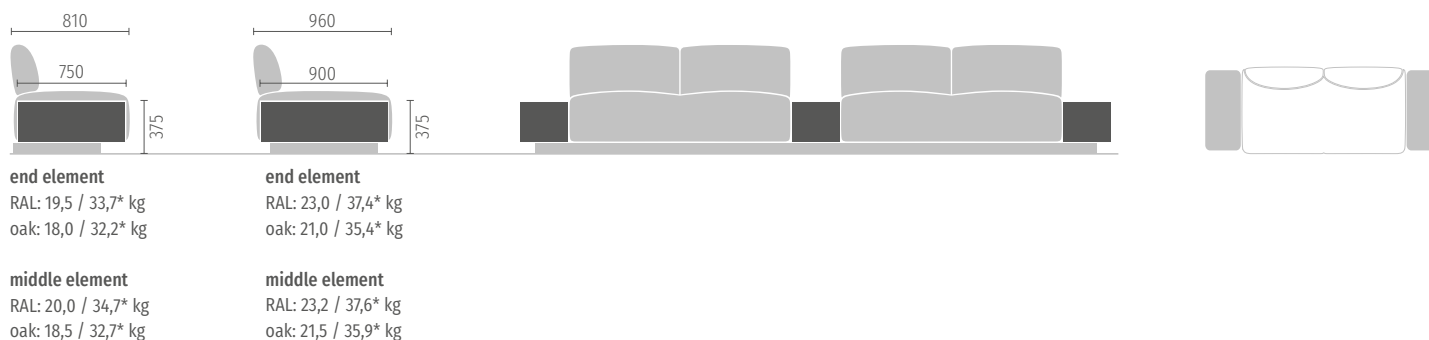

Add-on table

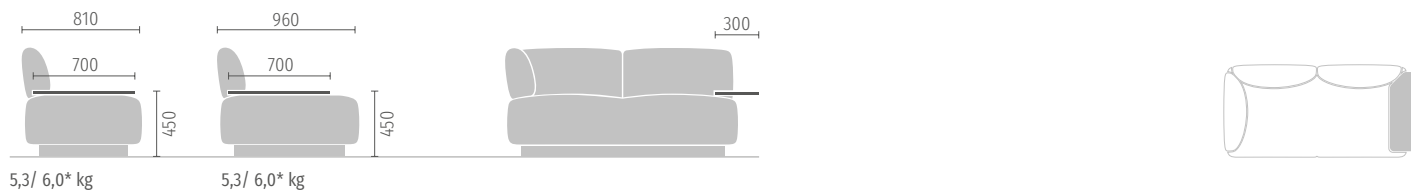

Tables

Round side tables

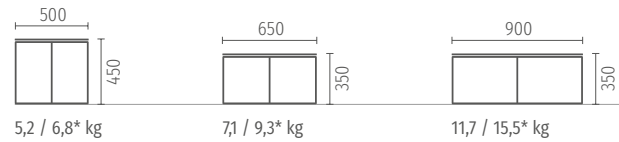

Square side tables

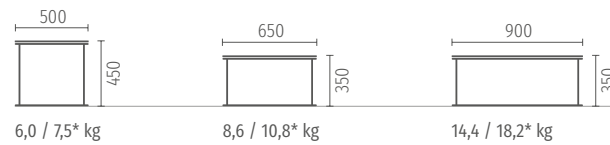

Triangle side tables

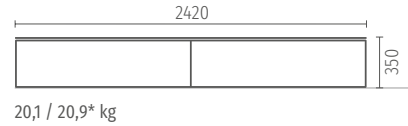

Cushions

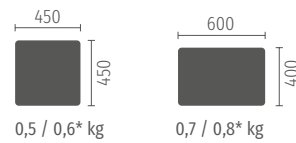

Upholstery*
PG0 – €€€€



Leather



Upholstery*
PG1 – €€€€

Breeze Fusion

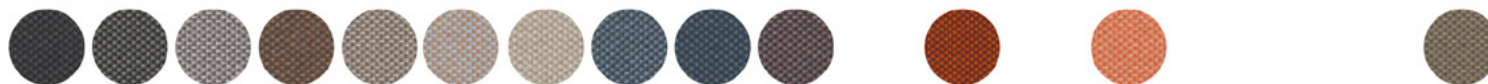

Morph



Steelcut Trio 3



Upholstery*
PG2 – €€€€

Milano



Nobel ★



Remix

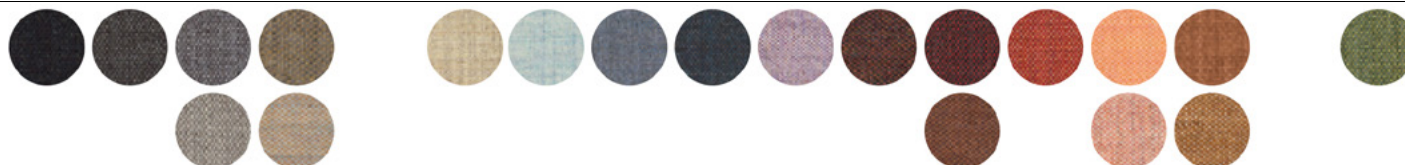

Tempt



* Armrest and backrest can be upholstered in different colours and in a mix of materials

★ = Update 2024

Upholstery*
PG4 – €€€€







































Connect	
Cura	
Cyber*	
Fame	
Pure	
Step/ Step Melange	
Imitation leather	

* Armrest and backrest can be upholstered in different colours and in a mix of materials

★ = Update 2024

Upholstery*
PG9 – €€€€



Atlantic															
Era															
One ★															
Phoenix															

* Armrest and backrest can be upholstered in different colours and in a mix of materials

★ = Update 2024

Plinth, storage/
corner elements



Coatings



black grey (RAL 7021), light grey (RAL 7044), natural oak

When the storage element or corner table are combined with the sofa elements, they come in the same colour as the plinth

Add-on tables



Veneers



Melamine
Wood Selection



Side table tops



Melamine
Architecture Line



Melamine
Colour Harmony



Soft touch
(HPL)



Side table frames



powdercoated

